

# SN75C189, SN75C189A QUADRUPLE LOW-POWER LINE RECEIVERS

SLLS041G – OCTOBER 1988 – REVISED JANUARY 2000

- Meet or Exceed the Requirements of TIA/EIA-232-F and ITU Recommendation V.28
- Low Supply Current . . . 420  $\mu$ A Typ
- Preset On-Chip Input Noise Filter
- Built-in Input Hysteresis
- Response and Threshold Control Inputs
- Push-Pull Outputs
- Functionally Interchangeable and Pin-to-Pin Compatible With Texas Instruments SN75189/SN75189A and Motorola MC1489/MC1489A
- Package Options Include Plastic Small-Outline (D) and Shrink Small-Outline (DB) Packages, and Standard Plastic (N) DIP

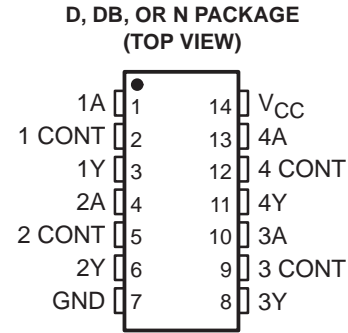

## description

The SN75C189 and SN75C189A are low-power, bipolar, quadruple line receivers that are used to interface data terminal equipment (DTE) with data circuit-terminating equipment (DCE). These devices have been designed to conform to TIA/EIA-232-F.

The SN75C189 has a 0.33-V typical hysteresis, compared with 0.97 V for the SN75C189A. Each receiver has provision for adjustment of the overall input threshold levels. This is achieved by choosing external series resistors and voltages to provide bias levels for the response-control pins. The output is in the high logic state if the input is open circuit or shorted to ground.

These devices have an on-chip filter that rejects input pulses of less than 1- $\mu$ s duration. An external capacitor can be connected from the control pins to ground to provide further input noise filtering for each receiver.

The SN75C189 and SN75C189A have been designed using low-power techniques in a bipolar technology. In most applications, these receivers interface to single inputs of peripheral devices such as UARTs, ACEs, or microprocessors. By using sampling, such peripheral devices usually are insensitive to the transition times of the input signals. If this is not the case, or for other uses, it is recommended that the SN75C189 and SN75C189A outputs be buffered by single Schmitt input gates or single gates of the HCMOS, ALS, or 74F logic families.

The SN75C189 and SN75C189A are characterized for operation from 0°C to 70°C.



Please be aware that an important notice concerning availability, standard warranty, and use in critical applications of Texas Instruments semiconductor products and disclaimers thereto appears at the end of this data sheet.

PRODUCTION DATA information is current as of publication date. Products conform to specifications per the terms of Texas Instruments standard warranty. Production processing does not necessarily include testing of all parameters.

 **TEXAS  
INSTRUMENTS**

POST OFFICE BOX 655303 • DALLAS, TEXAS 75265

Copyright © 2000, Texas Instruments Incorporated

# SN75C189, SN75C189A QUADRUPLE LOW-POWER LINE RECEIVERS

SLLS041G – OCTOBER 1988 – REVISED JANUARY 2000

## logic symbol†

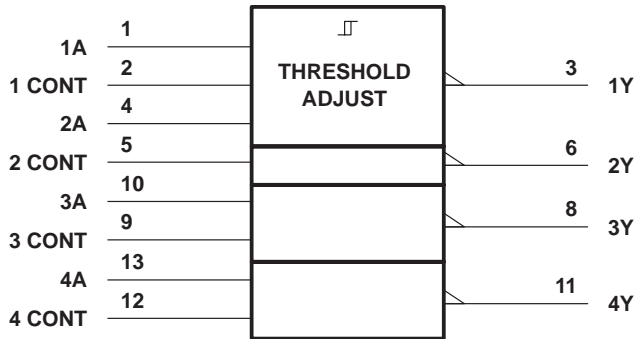

## logic diagram (each receiver)

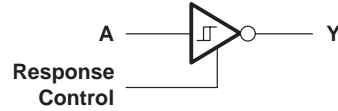

† This symbol is in accordance with ANSI/IEEE Std 91-1984 and IEC Publication 617-12.

## schematic of inputs and outputs

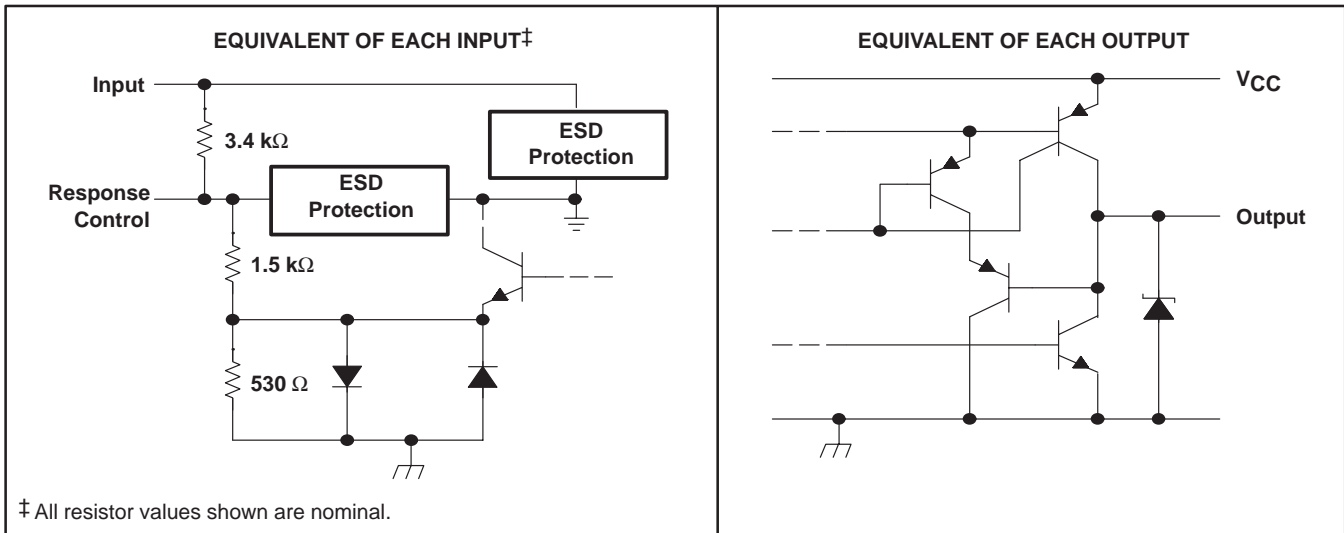

‡ All resistor values shown are nominal.

## absolute maximum ratings over operating free-air temperature range (unless otherwise noted)§

Supply voltage, $V_{CC}$ (see Note 1)	7 V
Input voltage range, $V_I$	-30 V to 30 V
Output voltage range, $V_O$	-0.3 V to $V_{CC} + 0.3$ V
Package thermal impedance, $\theta_{JA}$ (see Note 2):	
D package	86°C/W
DB package	96°C/W
N package	80°C/W
Lead temperature 1,6 mm (1/16 inch) from case for 10 seconds	260°C
Storage temperature range, $T_{stg}$	-65°C to 150°C

§ Stresses beyond those listed under "absolute maximum ratings" may cause permanent damage to the device. These are stress ratings only, and functional operation of the device at these or any other conditions beyond those indicated under "recommended operating conditions" is not implied. Exposure to absolute-maximum-rated conditions for extended periods may affect device reliability.

NOTES: 1. All voltages are with respect to network GND.

2. The package thermal impedance is calculated in accordance with JESD 51.



POST OFFICE BOX 655303 • DALLAS, TEXAS 75265

# SN75C189, SN75C189A QUADRUPLE LOW-POWER LINE RECEIVERS

SLLS041G – OCTOBER 1988 – REVISED JANUARY 2000

## recommended operating conditions

	MIN	NOM	MAX	UNIT
V <sub>CC</sub> Supply voltage	4.5	5	6	V
V <sub>I</sub> Input voltage (see Note 3)	-25		25	V
I <sub>OH</sub> High-level output current			-3.2	mA
I <sub>OL</sub> Low-level output current			3.2	mA
Response-control current			±1	mA
T <sub>A</sub> Operating free-air temperature	0		70	°C

NOTE 3: The algebraic convention, where the more positive (less negative) limit is designated as maximum, is used in this data sheet for logic levels only, e.g., if -10 V is a maximum, the typical value is a more negative voltage.

## electrical characteristics over recommended free-air temperature range, V<sub>CC</sub> = 5 V ±10% (unless otherwise noted) (see Note 4)

PARAMETER		TEST CONDITIONS	MIN	TYP†	MAX	UNIT
V <sub>IT+</sub> Positive-going input threshold voltage	'C189	See Figure 1	1		1.5	V
	'C189A		1.6		2.25	
V <sub>IT-</sub> Negative-going input threshold voltage	'C189	See Figure 1	0.75		1.25	V
	'C189A		0.75	1	1.25	
V <sub>hys</sub> Input hysteresis voltage (V <sub>IT+</sub> - V <sub>IT-</sub> )	'C189	See Figure 1	0.15	0.33		V
	'C189A		0.65	0.97		
V <sub>OH</sub> High-level output voltage		V <sub>CC</sub> = 4.5 V to 6 V, V <sub>I</sub> = 0.75 V, I <sub>OH</sub> = -20 μA	3.5			V
		V <sub>CC</sub> = 4.5 V to 6 V, V <sub>I</sub> = 0.75 V, I <sub>OH</sub> = -3.2 mA	2.5			
V <sub>OL</sub> Low-level output voltage		V <sub>CC</sub> = 4.5 V to 6 V, V <sub>I</sub> = 3 V, I <sub>OL</sub> = 3.2 mA			0.4	V
I <sub>IH</sub> High-level input current		See Figure 2	V <sub>I</sub> = 25 V	3.6	8.3	mA
			V <sub>I</sub> = 3 V	0.43	1	
I <sub>IL</sub> Low-level input current		See Figure 2	V <sub>I</sub> = -25 V	-3.6	-8.3	mA
			V <sub>I</sub> = -3 V	-0.43	-1	
I <sub>OS</sub> Short-circuit output current		See Figure 3			-35	mA
I <sub>CC</sub> Supply current		V <sub>I</sub> = 5 V, No load, See Figure 2		420	700	μA

† All typical values are at T<sub>A</sub> = 25°C.

NOTE 4: All characteristics are measured with response-control terminal open.

## switching characteristics, V<sub>CC</sub> = 5 V ±10%, T<sub>A</sub> = 25°C

PARAMETER	TEST CONDITIONS	MIN	TYP	MAX	UNIT
t <sub>pLH</sub> Propagation delay time, low- to high-level output	R <sub>L</sub> = 5 kΩ, C <sub>L</sub> = 50 pF, See Figure 4			6	μs
t <sub>pHL</sub> Propagation delay time, high- to low-level output				6	μs
t <sub>TLH</sub> Transition time, low- to high-level output‡				500	ns
t <sub>THL</sub> Transition time, high- to low-level output‡				300	ns
t <sub>w(N)</sub> Duration of longest pulse rejected as noise§			1		6

‡ Measured between 10% and 90% points of output waveform

§ The receiver ignores any positive- or negative-going pulse that is less than the minimum value of t<sub>w(N)</sub> and accepts any positive- or negative-going pulse greater than the maximum of t<sub>w(N)</sub>.



# SN75C189, SN75C189A QUADRUPLE LOW-POWER LINE RECEIVERS

SLLS041G – OCTOBER 1988 – REVISED JANUARY 2000

## PARAMETER MEASUREMENT INFORMATION

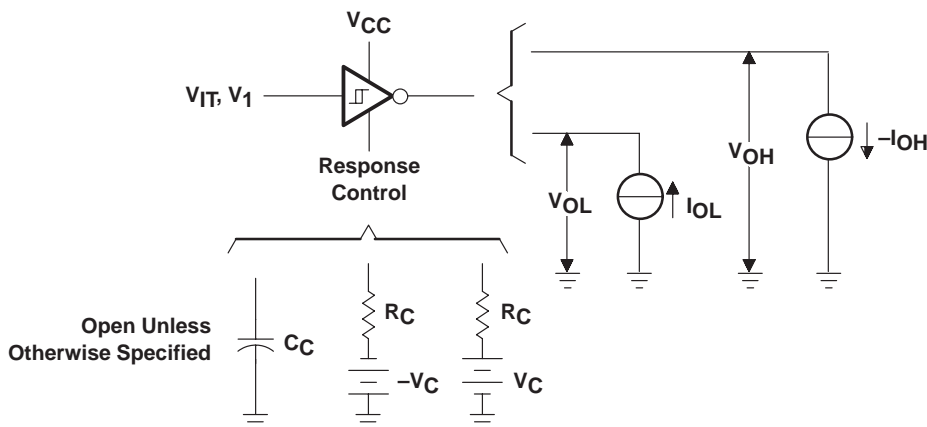

NOTE A: Arrows indicate actual direction of current flow. Current into a terminal is a positive value.

Figure 1.  $V_{T+}$ ,  $V_{IT-}$ ,  $V_{OH}$ ,  $V_{OL}$

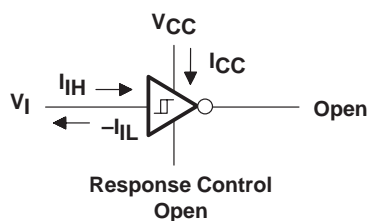

NOTE A: Arrows indicate actual direction of current flow. Current into a terminal is a positive value.

Figure 2.  $I_{iH}$ ,  $I_{iL}$ ,  $I_{CC}$

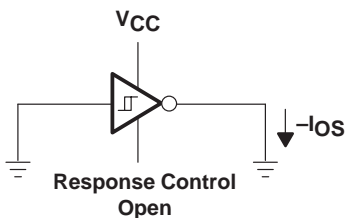

NOTE A: Arrows indicate actual direction of current flow. Current into a terminal is a positive value.

Figure 3.  $I_{OS}$

PARAMETER MEASUREMENT INFORMATION

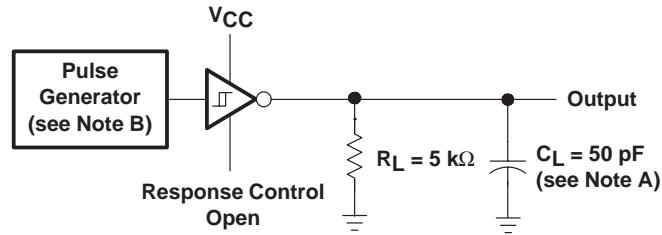

TEST CIRCUIT

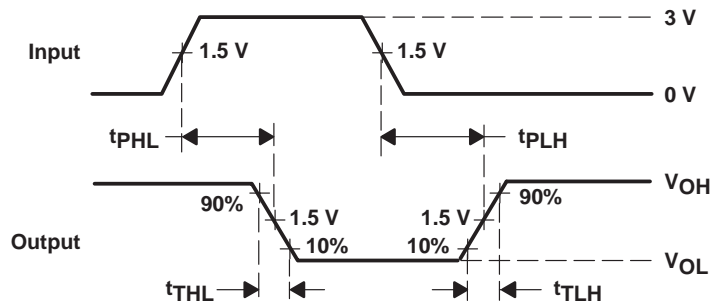

VOLTAGE WAVEFORMS

- NOTES: A.  $C_L$  includes probe and jig capacitances.  
 B. The pulse generator has the following characteristics:  $Z_O = 50\ \Omega$ ,  $t_w = 25\ \mu\text{s}$ .

Figure 4. Test Circuit and Voltage Waveforms

# SN75C189, SN75C189A QUADRUPLE LOW-POWER LINE RECEIVERS

SLLS041G – OCTOBER 1988 – REVISED JANUARY 2000

## TYPICAL CHARACTERISTICS

**SN75C189**  
INPUT THRESHOLD VOLTAGE (POSITIVE GOING)  
vs  
FREE-AIR TEMPERATURE

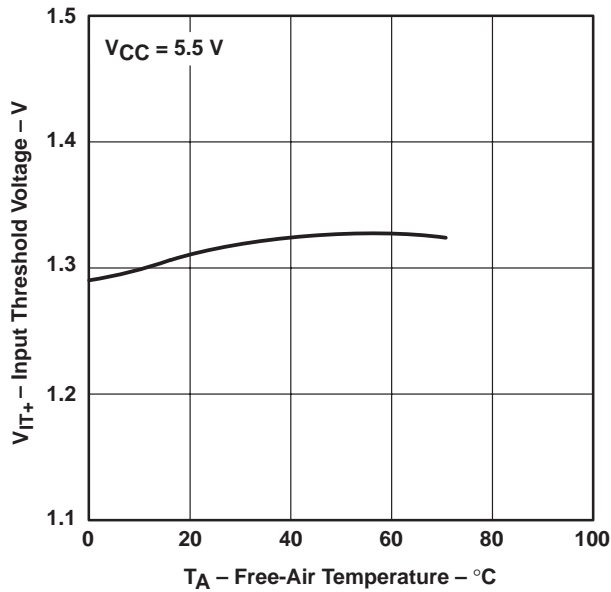

Figure 5

**SN75C189A**  
INPUT THRESHOLD VOLTAGE (POSITIVE GOING)  
vs  
FREE-AIR TEMPERATURE

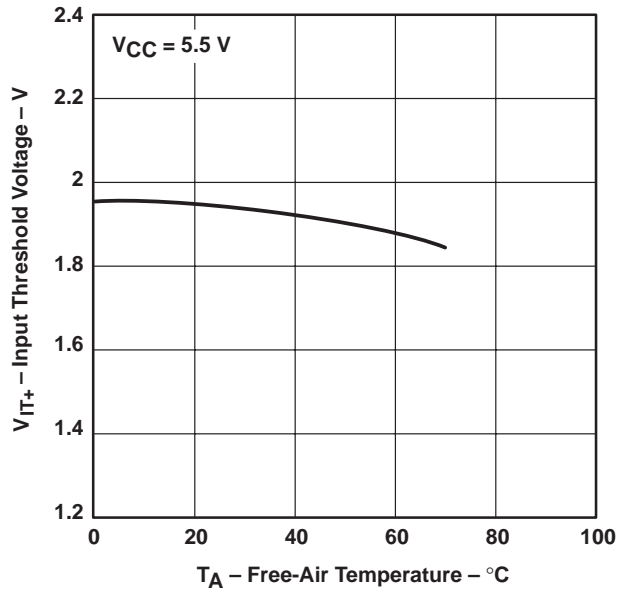

Figure 6

**SN75C189**  
INPUT THRESHOLD VOLTAGE (NEGATIVE GOING)  
vs  
FREE-AIR TEMPERATURE

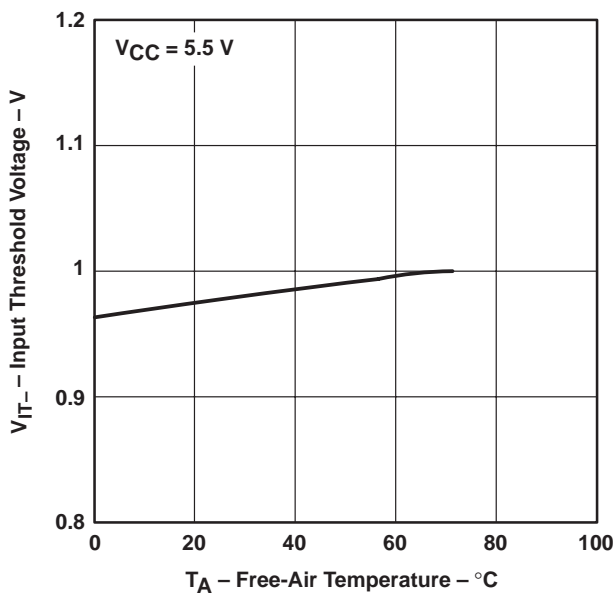

Figure 7

**SN75C189A**  
INPUT THRESHOLD VOLTAGE (NEGATIVE GOING)  
vs  
FREE-AIR TEMPERATURE

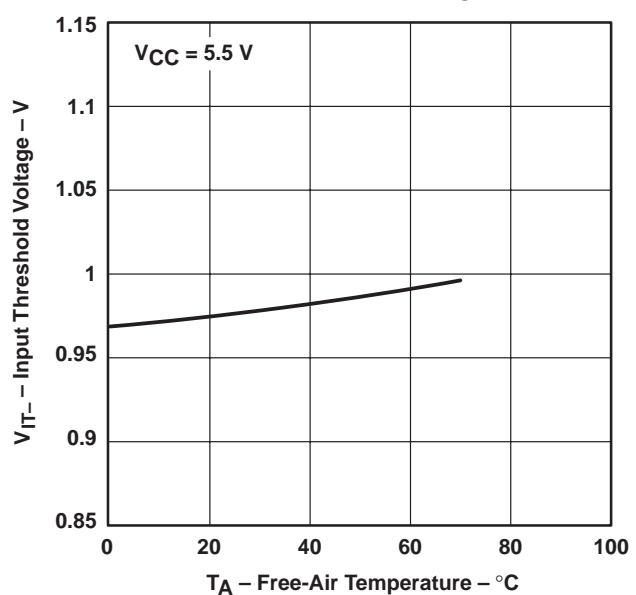
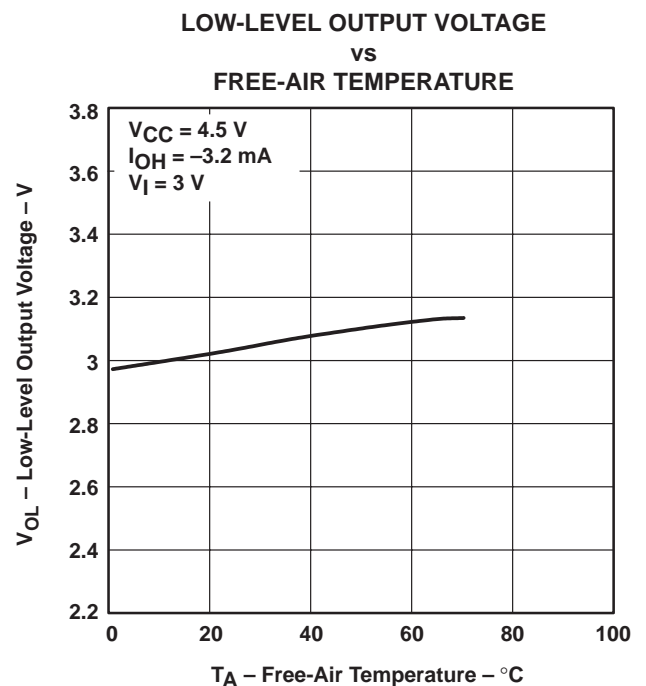
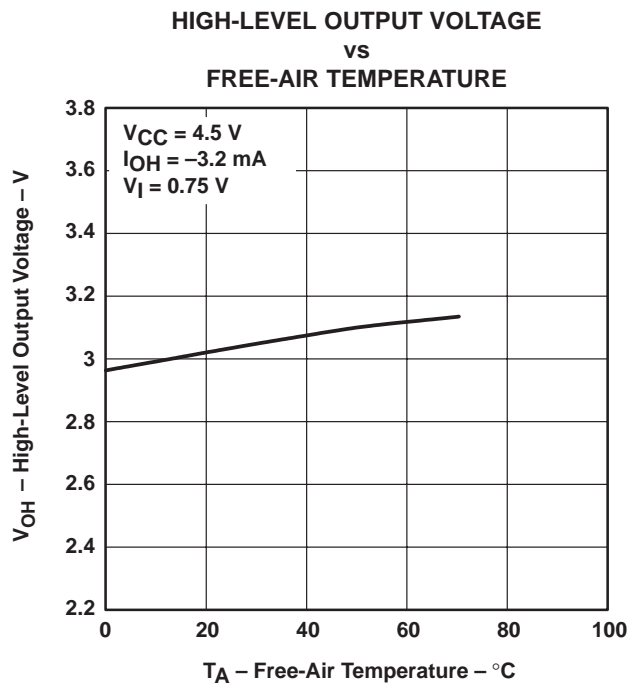
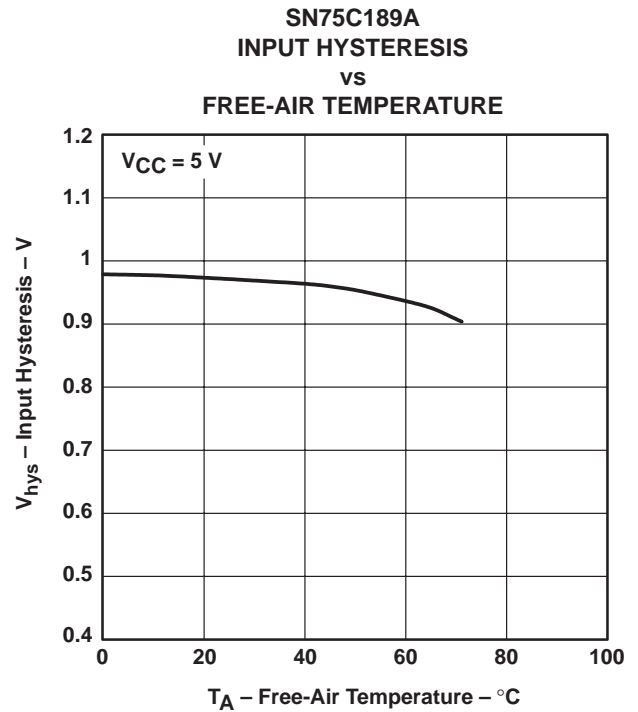
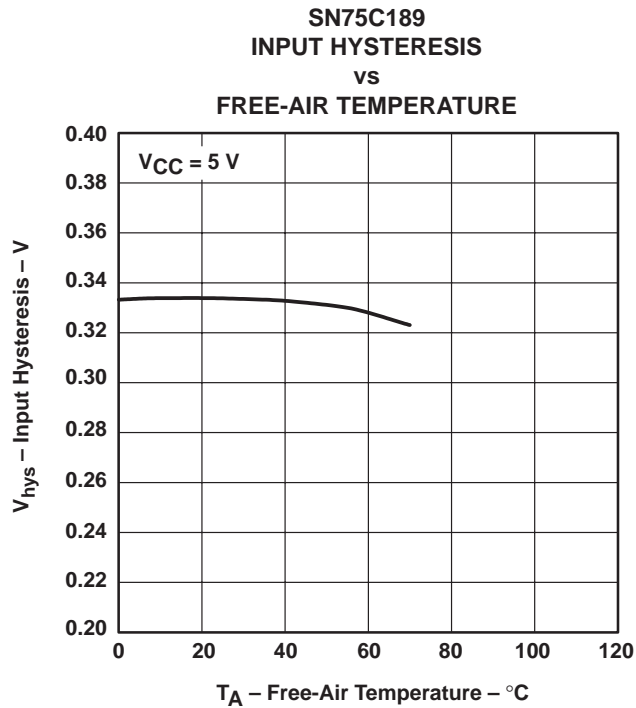

Figure 8



TYPICAL CHARACTERISTICS



# SN75C189, SN75C189A QUADRUPLE LOW-POWER LINE RECEIVERS

SLLS041G – OCTOBER 1988 – REVISED JANUARY 2000

## TYPICAL CHARACTERISTICS

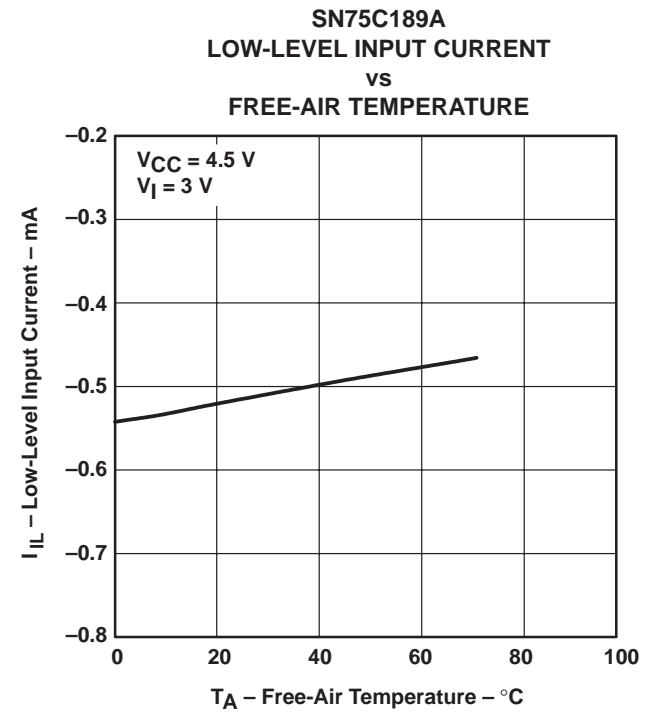
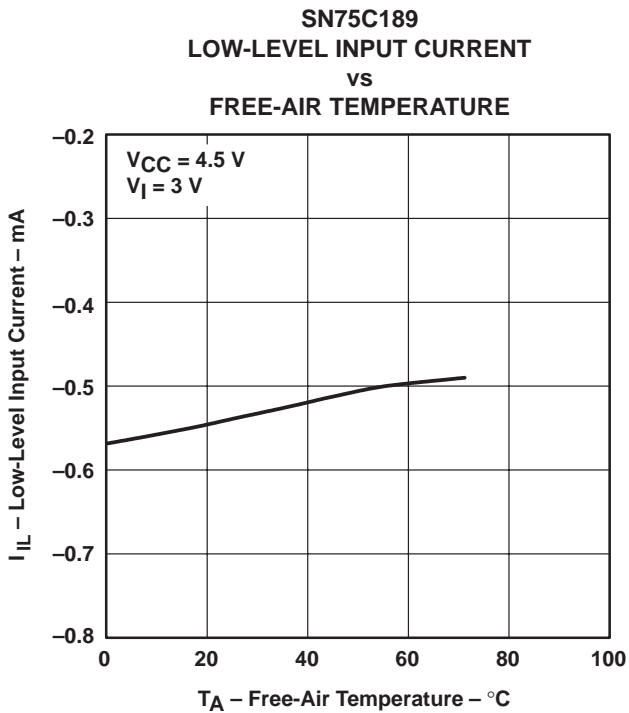
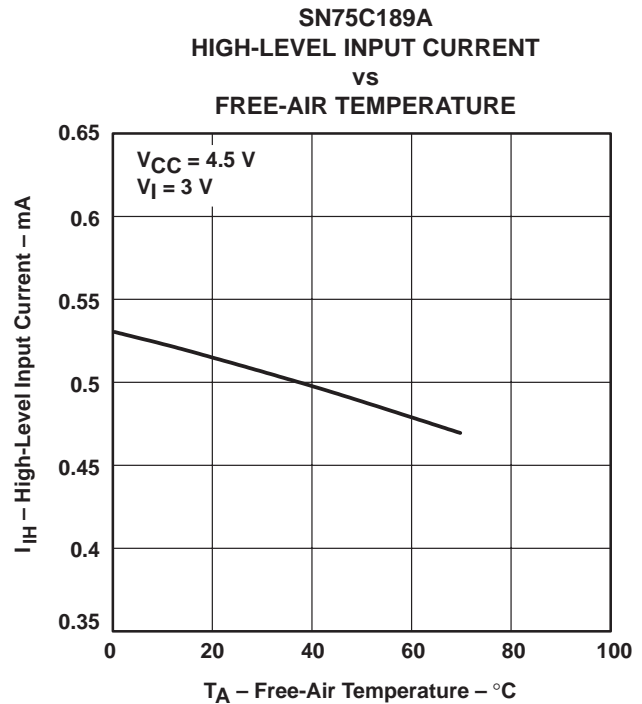
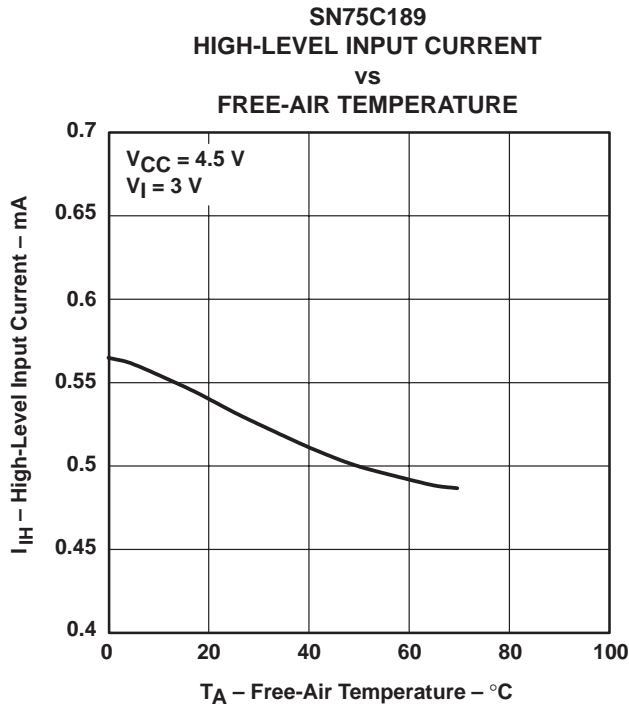



TYPICAL CHARACTERISTICS

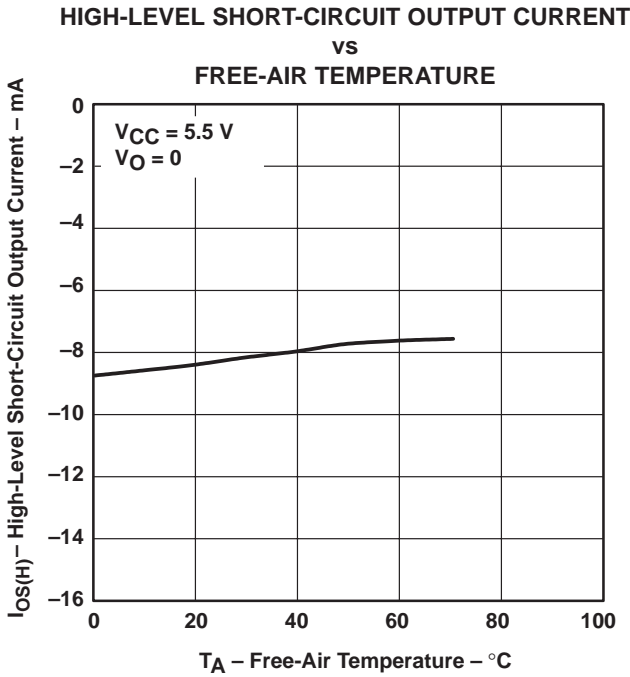

Figure 17

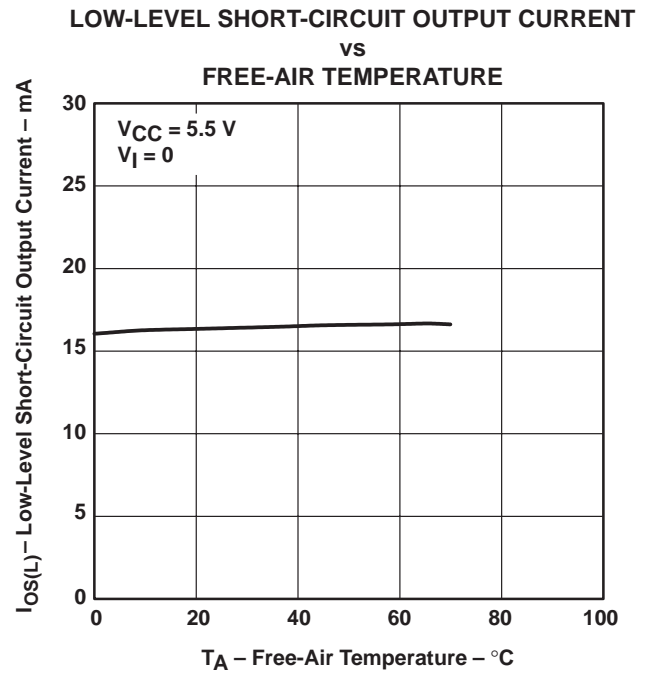

Figure 18

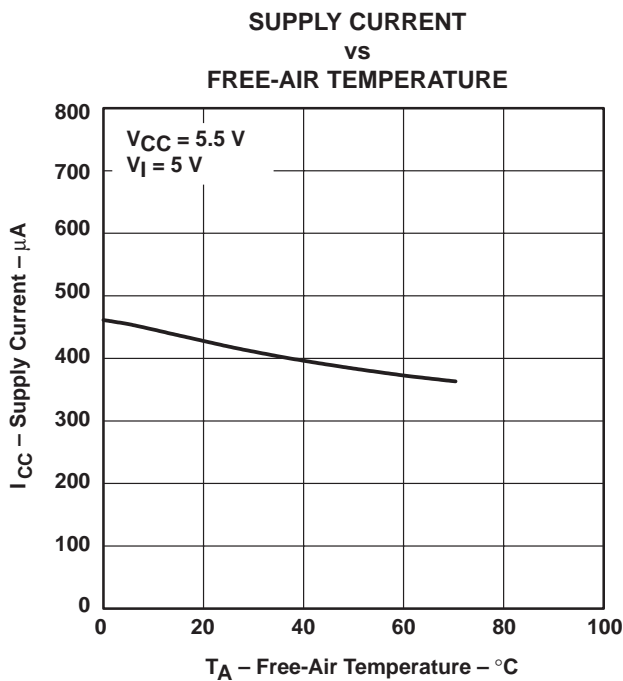

Figure 19

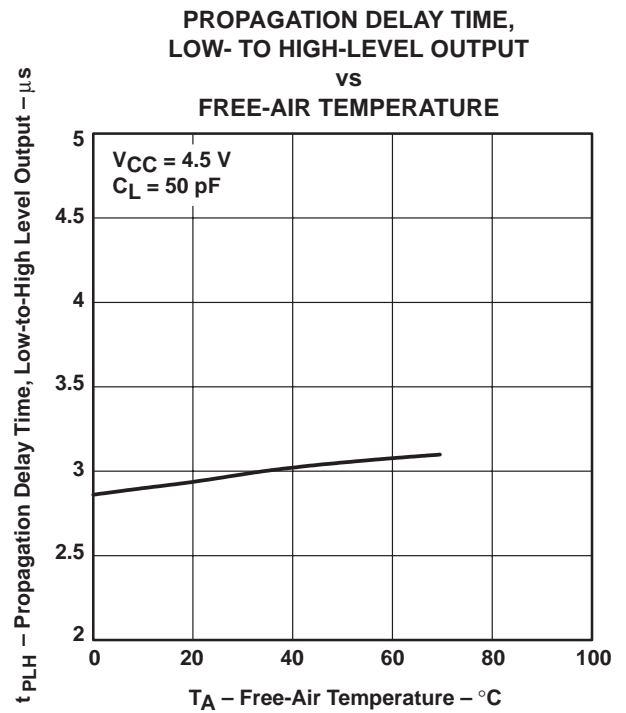

Figure 20

# SN75C189, SN75C189A QUADRUPLE LOW-POWER LINE RECEIVERS

SLLS041G – OCTOBER 1988 – REVISED JANUARY 2000

## TYPICAL CHARACTERISTICS

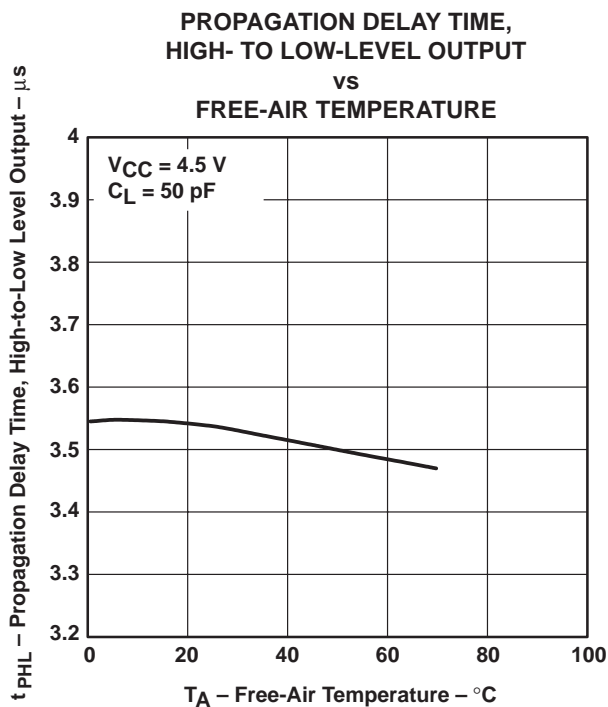

Figure 21

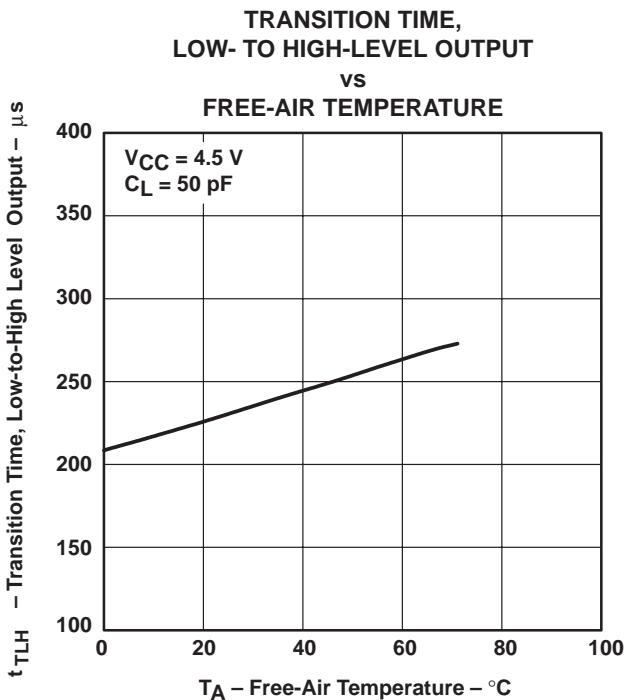

Figure 22

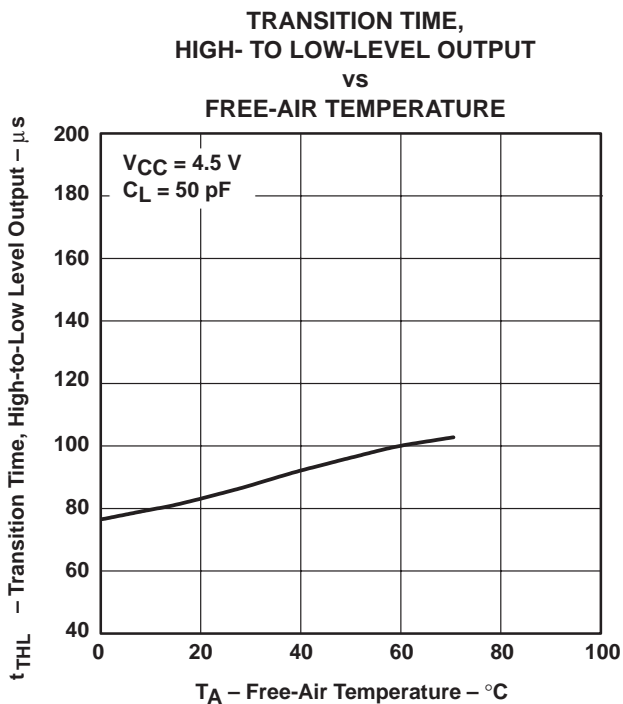

Figure 23



## IMPORTANT NOTICE

Texas Instruments and its subsidiaries (TI) reserve the right to make changes to their products or to discontinue any product or service without notice, and advise customers to obtain the latest version of relevant information to verify, before placing orders, that information being relied on is current and complete. All products are sold subject to the terms and conditions of sale supplied at the time of order acknowledgement, including those pertaining to warranty, patent infringement, and limitation of liability.

TI warrants performance of its semiconductor products to the specifications applicable at the time of sale in accordance with TI's standard warranty. Testing and other quality control techniques are utilized to the extent TI deems necessary to support this warranty. Specific testing of all parameters of each device is not necessarily performed, except those mandated by government requirements.

CERTAIN APPLICATIONS USING SEMICONDUCTOR PRODUCTS MAY INVOLVE POTENTIAL RISKS OF DEATH, PERSONAL INJURY, OR SEVERE PROPERTY OR ENVIRONMENTAL DAMAGE ("CRITICAL APPLICATIONS"). TI SEMICONDUCTOR PRODUCTS ARE NOT DESIGNED, AUTHORIZED, OR WARRANTED TO BE SUITABLE FOR USE IN LIFE-SUPPORT DEVICES OR SYSTEMS OR OTHER CRITICAL APPLICATIONS. INCLUSION OF TI PRODUCTS IN SUCH APPLICATIONS IS UNDERSTOOD TO BE FULLY AT THE CUSTOMER'S RISK.

In order to minimize risks associated with the customer's applications, adequate design and operating safeguards must be provided by the customer to minimize inherent or procedural hazards.

TI assumes no liability for applications assistance or customer product design. TI does not warrant or represent that any license, either express or implied, is granted under any patent right, copyright, mask work right, or other intellectual property right of TI covering or relating to any combination, machine, or process in which such semiconductor products or services might be or are used. TI's publication of information regarding any third party's products or services does not constitute TI's approval, warranty or endorsement thereof.